

IsatDock2 DRIVE



Inmarsat Approved

User Manual

Beam IsatDock2 DRIVE User Manual

Product name: IsatDock2 DRIVE

Manual revision: 01

Part Number: USRMAN007901

Release date: October 2014

Beam Communications Pty Ltd
5/8 Anzed Court, Mulgrave,
Victoria, 3170, AUSTRALIA

Information furnished by Beam Communications Pty Ltd (Beam) is believed to be accurate and reliable. However, no responsibility is assumed by Beam for its use, or for any infringement of patents or other rights of third parties, which may result from its use. No license is granted by implication or otherwise under any patent or patent rights of Beam. Beam reserves the right to change specifications at any time without notice.

Copyright © 2017 Beam Communications Pty Ltd. All rights reserved

About Beam Communications

Beam Communications, a wholly owned subsidiary of World Reach Limited (WRR), listed on the Australian Stock Exchange, is a world leader in design, manufacture and distribution of specialised communications equipment for the Inmarsat Satellite Network.

Beam's commitment to be at the forefront has continued to increase its share of the global satellite communications market. Its premium distribution network spans the world.

Recognized as a leading provider of satellite communication solutions, **Beam** specializes in Voice, Data, Tracking and customized solutions. **Beam** develops innovative products and services to meet market demands and niche applications.

Beam's leading edge products are deployed in a wide range of vertical markets including Maritime, Transport, Government, Defence, Mining, Construction, Forestry, Emergency Services, Relief Aid, Telemetry and Rural Telephony.

Supported by a dedicated team of professionals, **Beam** has developed solid relationships with its peers and network of distributors worldwide.



Beam Communications Pty Ltd

5/8 Anzed Court, Mulgrave,
Victoria, 3170, AUSTRALIA

Web: www.beamcommunications.com
Information: info@beamcommunications.com
Support: support@beamcommunications.com

Tel: +61 3 8588 4500
Fax: +61 3 9560 9055

Conventions in this Manual

These notes will appear throughout this manual and should be taken into consideration.



Warning or Caution

This symbol and associated text indicate a warning note providing information to prevent damage to equipment or personal injury.



Note/Important/Tip Header

This symbol and associated text indicate a note providing general operating information.



Interference Header

All wireless phones may get interference, which could affect performance.



Record Header

Write details of your unit for easy reference when required. Ideal when troubleshooting.

Terminology

TERM	DESCRIPTION
Falcon	Falcon Configuration Tool - MS Windows Install
SMS	Short Message Service
Mobile Originating	Describes a call initiated by the IsatDock2
Mobile Terminating	Describes an incoming call being answered by the IsatDock2
IsatPhone 2	The Inmarsat IsatPhone 2 handset
®	The ® symbol, mark and logos are owned by the respective companies of which the symbol follows. Any use of such marks by Beam Communications is under license. Other trademarks and trade names are those of their respective owners.
RF	Radio Frequencies
SMA	Sub Miniature version A co-axial RF connection
RJ9	4P4C connector for the privacy handset
GPS	Global Positioning System
GSPS	Inmarsat's Global Satellite Phone Service

Package Contents

Check that your IsatDock2 DRIVE package contains all of the following items:

- 1 x IsatDock2 DRIVE docking station
- 2 x IsatDock2 Adapters
- 1 x DC Power Cable / Lead
- 1 x Universal Mounting Bracket (RAM®)
- 3 x M4 Screws and washers
- 1 x Fuse Kit
- 1 x Speaker
- 1 x Microphone
- User Manual
- Quick Start Guide

Falcon Configuration Tool

is available for download from:

<http://www.beamcommunications.com/support/isd2drive>

Optional Accessories

The following optional accessories are available for your IsatDock2 DRIVE

Active Antennas

- ISD715 Transport Magnetic Antenna (Active)
- ISD720 Transport Bolt Antenna (Active)

Antenna Cable Kits for Active Antennas

- ISD932 6m cable kit (Active)
- ISD933 13m cable kit (Active)
- ISD934 18m cable kit (Active)
- ISD935 31m cable kit (Active)
- ISD938 40m cable kit (Active)
- ISD942 50m cable kit (Active)
- ISD943 60m cable kit (Active)
- ISD944 70m cable kit (Active)
- ISD945 80m cable kit (Active)
- ISD946 90m cable kit (Active)
- ISD947 100m cable kit (Active)

Additional Accessories

- ISD955 Privacy Handset
- ISD950 110-240v AC plug pack
- ISD960 IsatDock2 Adapter
- RST060 Beam GoalZERO UPS Battery Pack
- RST410 "Man Down Pendant" kit

See your service provider for pricing and availability of these quality Beam accessories.

Additional Information

For the latest in supporting software and documentation for IsatDock2 DRIVE please contact

www.beamcommunications.com/support/isd2drive

Other Resources Available Online

- Advanced Configuration – in-built to Falcon
- Quick Start Guide & Manual
- Antenna Installation Guide
- IsatPhone 2 firmware upgrade if required



Personal Alert

Personal Alert functionality must be configured on the IsatPhone 2 handset directly.

The Personal Alert button on the IsatDock2 DRIVE will only operate once the IsatPhone 2 has been configured.

CONTENTS

IsatDock2 DRIVE Part Number	2	IsatDock2 DRIVE Key Features	11	Personal Alert and Assistance Alert Operations	
About Beam Communications	3	Personal Alert and Assistance Alert Configuration Using Falcon		IsatDock2 DRIVE Front Panel	
Conventions in this Manual	4	Configuration Using Remote Commands		IsatDock2 DRIVE Buttons/LED lights	
Terminology				Assuring Quality of Service	
Package Contents	5	Equipment Overview	13	Specification Summary	28
Optional Accessories		Docking & Undocking IsatPhone 2 handset	14	Electrical & Environmental Specifications - IsatDock2 DRIVE	
Additional Information		Installation Guidelines	15	(1) Physical Dimensions - DRIVE Dock	
Beam Alert Loop		Routing Cables (for vehicle installations)		(2) Physical Dimensions - Privacy Handset	
Other Resources Available Online		Guidelines for Electrical Connections		Trouble Shooting	30
Safety Information	7	Installation Procedure	16	Beam Warranty Conditions	31
Safety Transceiver IsatPhone 2		Installing the IsatDock2 DRIVE Cradle			
IsatDock2 FCC Information		IsatDock2 DRIVE Usage	22		
Electronic Devices		Operation of the IsatPhone 2			
Pacemakers		Placing Voice Calls			
Other Medical Devices		Privacy Handset Use (Optional Accessory)			
Vehicles		Mute Mode			
Posted Facilities		USB Driver Installation			
Aircraft					
Vehicles Equipped with an Air Bag					

Safety Information



IMPORTANT

Please read the following information carefully before installing and using the IsatDock2 DRIVE. Failing to follow instructions may compromise the safety of the product and may result in personal injury and/or equipment damage. Please consult your supplier if you have any further questions.

The IsatDock2 DRIVE is a low power docking station for the IsatPhone 2 handset. When ON, it will charge the IsatPhone 2 handset whilst docked in the IsatDock2 DRIVE.

Refer to the appropriate section of this IsatDock2 DRIVE Installation & User Manual for additional safety information.

- Store the system in a cool and dry area.
- Do not submerge the system in water.
- Do not place foreign metal objects or debris in the system. If debris enters into the system, please return to factory for service.



WARNING

DO NOT open equipment. There are no user-serviceable parts inside.

If a DC power supply is to be used, its output must comply with the Safety Extra Low Voltage (SELV) requirements of IEC60950.

All connectors must only be connected to equipment ports which comply with the Safety Extra Low Voltage (SELV) requirements of IEC60950.

POTENTIALLY EXPLOSIVE ATMOSPHERES

- Turn your phone OFF and DO NOT remove your battery or remove the IsatPhone 2 handset from the cradle when you are in any area with a potentially explosive atmosphere.
- Obey all signs and instructions.
- Sparks from your battery in such areas could cause an explosion or fire resulting in bodily injury or even death.

- Areas with a potentially explosive atmosphere are often but not always clearly marked. They include, but are not limited to:
 - » fuelling areas such as gasoline stations
 - » below deck on boats;
 - » fuel or chemical transfer or storage facilities;
 - » areas where fuel odors are present (for example, if a gas/propane leak occurs in a car or home);
 - » areas where the air contains chemicals or particles, such as grain, dust, or metal powders;
 - » any other area where you normally would be advised to turn off your vehicle engine.

Safety transceiver IsatPhone 2

Your handset is a low power radio transmitter and receiver. When it is ON, it receives and also sends out radio frequency (RF) signals. (NOTE: Refer to Inmarsat IsatPhone 2 Manual for additional Information)

- The Inmarsat IsatPhone 2 handset has an in-built transceiver which is designed to be used with an external antenna. This antenna transmits RF energy. The Beam antenna (fitted via an extension coaxial cable to the cradle) must be located more than > 55cm from the human body (person) when in operation.
- International agencies have set standards and recommendations for the protection of public exposure to RF electromagnetic energy. These standards are based on extensive scientific review by scientists, engineers, and physicians from universities, government health agencies, and industry groups. They review the available body of research to develop ANSI standard. These ANSI standards are reviewed regularly for research development.

- » International Commission on Non-Ionizing Radiation Protection (ICNIRP) 1996
- » Verband Deutscher Elektrotechniker (VDE) DIN-0848
- » United States Federal Commission, Radio Frequency Exposure Guidelines (1996)
- » National Radiological Protection Board of the United Kingdom, GS 11, 1988
- » American National Standards Institute (ANSI) IEEE. C95. 1-1992
- Do not operate your satellite system when a person is within 55cm of the external antenna. A person or object within 55cm of the external antenna could impair call quality and may cause the phone to operate at a higher power level than necessary and expose that person to RF energy in excess of that established by the FCC RF Exposure Guidelines.
- As a precaution, please maintain the maximum body distance possible from the antenna during call transmission.



WARNING

ROAD SAFETY COMES FIRST!

Do not use a hand-held cellular terminal, satellite phone or mobile when driving a vehicle, unless it is securely mounted in a holder for speaker phone operation. Before making a call with a handheld terminal, satellite phone or mobile, park the vehicle stationary. Please obey local road laws for hands-free speakerphone operation. Speakerphones (hands-free) must be installed by qualified personnel. Faulty installation or operation can constitute a safety hazard.



IMPORTANT

Cellular & Satellite terminals or mobiles operate using radio signals and communication networks. Because of this, the connection cannot be guaranteed at all times or under all conditions. Therefore, you should never rely solely upon any wireless device for essential communications, for example emergency calls.

IsatDock2 FCC Information

This equipment has been tested and found to comply with the limits for a Class B digital devices, pursuant to Part 15 of the FCC Rules. These limits are designed to provide reasonable protection against harmful interference in a residential installation. This equipment generates, uses, and can radiate radio frequency energy and, if not installed and used in accordance with the instruction manual, may cause harmful interference to radio communications. However, there is no guarantee that interference will not occur in a particular installation. If this equipment does cause harmful interference to radio or television reception, which can be determined by turning the equipment off and on, the user is encouraged to try to correct the interference by one or more of the following measures:

- Reorient or relocate the receiving antenna
- Increase the separation between the equipment and receiver
- Connect the equipment into an outlet on a circuit different from that to which the receiver is connected.
- Consult the dealer or an experienced radio/TV technician for help.

This device has been designed to operate with the ISD715 or ISD720 (AT1595-83) antennas that have a maximum gain of 6dBi. Antennas having a gain greater than 6dBi are strictly prohibited for use with this device.

To reduce potential radio interference to other users, the antenna type and its gain should be so chosen that the equivalent isotropically radiated power (EIRP) is not more than that required for successful communication



WARNING

Changes or modifications not expressly approved by Beam Communications could void the product warranty.

Electronic Devices

Most modern electronic equipment is shielded from RF signals. However, certain equipment may not be shielded against the RF signals from your wireless phone.

Pacemakers

The Health Industry Manufacturers Association recommends that a minimum separation of six inches (6") be maintained between a wireless phone's antenna and a pacemaker to avoid potential interference with the pacemaker. These recommendations are consistent with the independent research by and recommendations of Wireless Technology Research.

Persons with pacemakers:

- *Should ALWAYS keep the phone more than six inches from their pacemaker when phone is turned ON.*
- *Should turn the phone OFF immediately if you have any reason to suspect interference is taking place.*

Other Medical Devices

If you use any other personal medical device, consult the manufacturer of your device to determine if it is adequately shielded from external RF energy. Your physician may be able to assist you in obtaining this information.

Turn your phone OFF in health care facilities when any regulations posted in these areas instruct you to do so. Hospitals or health care facilities may be using equipment that could be sensitive to external RF energy.

Vehicles

RF signals may affect improperly installed or inadequately shielded electronic systems in motor vehicles. Check with the manufacturer or its representative regarding your vehicle. You should also consult the manufacturer of any equipment that has been added to your vehicle. Performance of electronically controlled brake and/or guidance systems can, under certain unique conditions, be subject to interference by mobile radio operation. Although the transceiver meets all requirements regarding RF emissions, you should mount the transceiver as far as possible from the guidance system and/or braking modulator box (usually located in the trunk) to minimize any interference.

Posted Facilities

Turn your phone OFF in any facility where posted notices require such as hospitals and on-board aircraft.

Aircraft

Airline regulations prohibit using your phone while in the air. Consult the local Aviation Authority for guidelines on use of the equipment on board an aircraft.

Vehicles Equipped with an Air Bag

An air bag inflates with great force. Do NOT place objects, including both installed and portable wireless equipment, in the area over the air bag or in the air bag deployment area. If in-vehicle wireless equipment is improperly installed and the air bag inflates, serious injury could result.

IsatDock2 DRIVE Key Features

IsatDock2 DRIVE is an intelligent compact docking station specifically designed for the Inmarsat IsatPhone 2 satellite handset.

IsatDock2 DRIVE allows the IsatPhone 2 handset to be used in a vehicle, enabling quality hands-free calls with echo cancellation and noise reduction support. IsatDock2 DRIVE support and provide easy access to many features of IsatPhone 2 whilst docked, such as Assistance Alert, instant Personal Alert and Tracking.

DESIGN

- Slimline design
- High quality ABS plastic
- Enhanced phone/docking mechanism
- Robust USB & Audio Connection
- Accessible control buttons
- Dedicated Personal Alert button on dock
- Compact external speaker and microphone
- Single action insertion
- Single button release
- RAM® universal mounting arm (included)
- Compact installation
- Integrated antenna connection (GPS/GSPS)
- Easy access to Assistance Alert & Track buttons on IsatPhone 2
- Best suited for vehicular applications

POWER

- 10-32V DC Input
- 110-240V AC plug pack, optional

BUTTONS ON DOCK

- Personal Alert button
- In-call mute
- Ringer volume UP/DOWN
- In-call volume UP/DOWN

PERSONAL ALERT & ASSISTANCE ALERT FUNCTIONALITY

- PERSONAL ALERT
 - Configured on IsatPhone 2
 - Instant Personal Alert button on dock
- ASSISTANCE ALERT
 - Configured on IsatPhone 2
 - Supports external I/O to trigger Assistance Alert via pendant or button activation

INTEGRATED HANDSFREE

- Superior echo cancellation
- Full duplex
- Attachable privacy handset (optional accessory)

OTHER FEATURES

- Charges IsatPhone 2
- Supports Assistance Alert & Tracking via IsatPhone 2
- 2 year repair/replacement warranty
- Privacy handset auto answer/hang up (optional)
- Adjustable in-built ringer
- Horn/light ringer alert
- Mute facility
- Status LED with adjustable brightness
- USB data access
- Includes IsatDock2 adapters (2x)

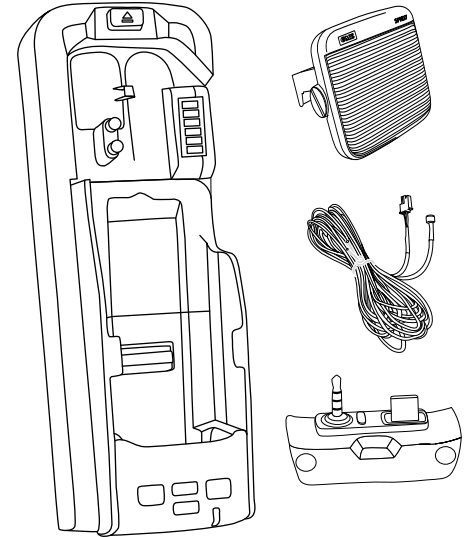

Personal Alert and Assistance Alert

IsatDock2 DRIVE supports the IsatPhone 2 Personal Alert and Assistance Button capabilities for various land and sea based applications.

The Personal Alert button is located on the front of the IsatDock2 DRIVE. A single button press on the dock will send an instant GPS position along with a short message to the recipient/s. This must be configured on IsatPhone 2 to enable a user to send an SMS or email to up to 10 recipients. Please refer to the IsatPhone 2 User Manual for further information.

The Assistance Alert feature can be triggered from the IsatDock2 DRIVE by using an external switch or wireless pendant connected to the Beam Alert Loop of the dock. Please ensure that the Assistance Alert settings in the IsatPhone 2 have been configured to enable to send a call, e-mail or SMS.



NOTE

For configuration of Personal Alert and Assistance Alert, refer to IsatPhone 2 User Manual.



NOTE

If the Beam Alert Loop is going to be used with an external button, remember to enable this external loop in the Falcon settings. Once enabled, the loop will be armed and activated with an open-loop condition, triggering on alert on the IsatPhone 2.

Configuration using Falcon

Falcon can be downloaded from:

<http://www.beamcommunications.com/support/isd2drive>

Follow the instructions in the downloaded application to install. Once complete, connect your PC to the USB port of the terminal and start Falcon. You can then use the application for a range of options such as:

- View the status of the IsatDock2 (signal, temperature, input voltage)
 - Firmware maintenance
-



NOTE

Entering the firmware upgrade mode will be accompanied by a long beep followed by three short beeps.

Configuration Using Remote Commands

Configuration instructions or “Remote Commands” can be sent to the terminal via SMS, and most settings are supported that are normally accessible from Falcon. Please refer to the Falcon user manual for more information.



NOTE

Due to memory limitations it is recommended that users have no more than 20 SMS messages in their inbox. If this amount is exceeded the processing of remote commands and the ability to retrieve the messages via the Falcon tool may be compromised.

Equipment Overview IsatDock2 DRIVE

1. IsatPhone 2 Eject Button
2. IsatPhone 2 (not included)
3. IsatPhone 2 docking Tray
4. Function Buttons
5. Status Indication Light
6. Power Cable Loom
 - a. Power Supply
 - b. Satellite Connector (TNC-Female)
 - c. GPS Connector (SMA-Female)
 - d. Microphone
 - e. Speaker
 - f. Beam Alert Loop (green & brown)
Horn Alert (blue)
Radio Mute (white)
7. RAM® Mounting
8. Privacy Handset Connection
9. Micro USB Data Connection
10. IsatDock2 Adapter
11. Speaker
12. Microphone

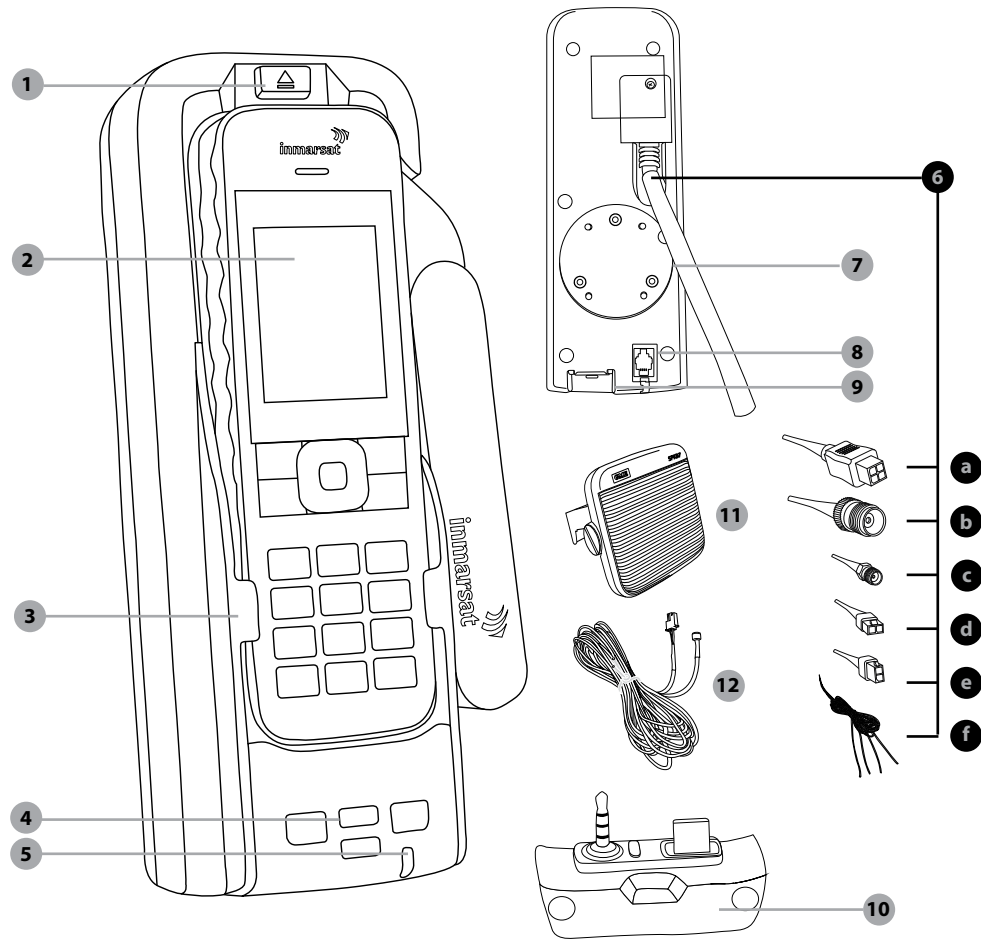

Docking & Undocking the IsatPhone 2 handset

To place the IsatPhone 2 into the docking unit, both the 'covers' on the external antenna connectors and the USB/Audio connectors need to be opened.

1. Lift the antenna 'cover' and rotate through 180 degrees, then push down into the open position.
2. The 'cover' in the base of the phone should be rotated 180 degrees to be in the open position.

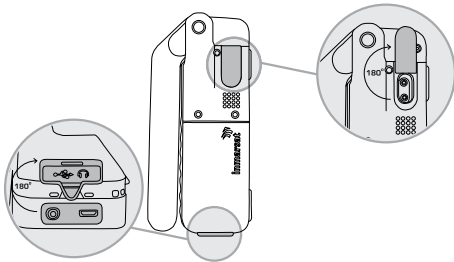

3. Detach the USB/Audio adapter from the dock and insert by hand in the base of the IsatPhone 2.

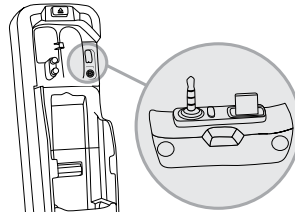

4. To dock the handset, open the antenna slightly, align the IsatPhone 2 with the phone tray and slide the handset down until it seats flush to the bottom of the tray. Swing the phone down into the cradle by applying pressure to the top of the handset. An audible 'click' is heard when the phone is in the docked position.

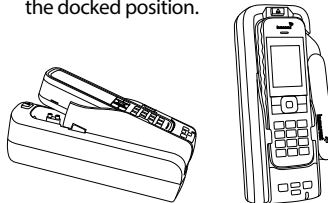

5. To remove the handset from the cradle, press the EJECT button at the top of the docking station. The dock will swing out and the handset can be removed.
6. Place the adapter back in its dedicated slot, when the phone is not in the docking unit.

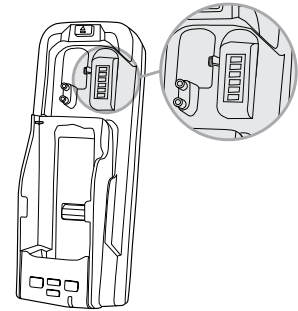

IMPORTANT:

Before docking the IsatPhone 2 to the docking station, check that the USB/Audio adapter has been connected to the IsatPhone 2.

Installation Guidelines

This guide outlines the process for installing the IsatDock2 DRIVE in conjunction with an Inmarsat IsatPhone 2 handset.

This kit must not be used with any other device other than the Inmarsat IsatPhone 2 handset.

- Only qualified personnel should install communication equipment. If necessary, contact the vehicle manufacturer for air bag information specific to the vehicle.
- Ensure that the units are protected from dirt and moisture.
- Select an area to mount components that do not interfere with driver or passengers seating or leg space.
- Ensure that each mounting surface is strong enough to support the component being mounted to prevent the component from loosening over time.
- Mount all components securely to prevent shifting that could cause injury or could interfere with safe vehicle operation. Always use the supplied mounting hardware.
- Leave space around the units to allow cooling and ensure there are adequate clearance for cables.
- Ensure the units can be easily removed.

Routing Cables (for vehicle installations)

- Route cables so they are protected from pinching, sharp edges, and crushing.



WARNING

Air bags inflate with great force. DO NOT place objects, including communication equipment, in the area over the air bag or in the air bag deployment area. If the communication equipment is improperly installed and the air bag inflates, serious injury could result.

-
- Where possible, avoid routing cables above the catalytic converter.
 - Use grommets wherever a cable must pass through a hole in a metal panel
 - In a vehicle equipped with electronically controlled anti-skid brakes, route all cables on the opposite side of the vehicle from the braking modulator box to minimize possible interference from the phone.
 - Keep all in-line connectors accessible.
 - The suggested path for routing cables in vehicles without wiring troughs is alongside the drive shaft hump, under the carpet.

Guidelines for Electrical Connections

The system is designed to operate in negative ground 10 to 32 Volt DC electrical systems only. If using the DC cable lead:

- The best power connection point for the positive primary power lead is the positive terminal of the vehicle battery. Often, direct connection to the battery is inconvenient, and you may find it easier to connect the positive leads to the starter solenoid. Always select a point as close as possible to the battery.
- Connect the negative primary power leads to a good ground point on the vehicle chassis or at the battery. If you must attach the negative primary power lead directly to the negative pole of the battery, you may optionally insert a 10-amp fuse (not included) into the ground (0V) line. Failure to insert a fuse can cause equipment to overheat if a wiring fault exists.
- Many parts of a vehicle can produce electrical noise that interferes with the electrical radio system operation. The ignition system is the most common source of electrical noise interference. Before you begin installation, ensure that the ignition wiring and connections to the vehicle battery are in good working condition.

- Verify that low resistance connections are present between the battery negative terminal, the vehicle chassis, and the engine block. All wire connections should be clean and tight.
- For vehicle installation, install provided fuses into the +BATT and ignition sense (accessory) wires.



WARNING

Do not connect the IsatDock2 interface power cable to power the unit until the full installation is completed.

Installation Procedure

Installing the IsatDock2 DRIVE Cradle

Install the components in the following order. More detailed instructions can be found in the sections following.

1. Mount the IsatDock2 DRIVE cradle
2. Install the external Beam antenna
3. Connect the speaker and microphone to the IsatDock2 DRIVE cradle
4. Connect the privacy handset (ordered as extra option)
5. Connect the DC power cable
6. Connecting Horn / Mute wires
7. Install the external alert button (optional)

When selecting a location for the IsatDock2 cradle, consider these guidelines:

- Ensure that each mounting surface is strong enough to support the cradle.
- Allow enough room so that you can easily insert the IsatPhone 2 handset in and out from the cradle.
- Ensure that the IsatDock2 is within cable distance of power and antenna connections
- Position the handset and cables so that it does not interfere with vehicle operation or with driver or passenger seating or leg space.

- Ensure sufficient room is allowed for the antenna and interface cables to be routed from the rear of the IsatDock2 cradle.
- Ensure the mounting position accounts for the antenna of the docked IsatPhone 2 that protrudes beyond the side of the dock (~17mm)

1) Mounting the IsatDock2 DRIVE cradle

The IsatDock2 DRIVE is supplied with a universal RAM® mounting arm that enables mounting to any flat surface (vertical or horizontal) within a vehicle, or other required location.

1. Attach one pivot base to the rear of the IsatDock2 DRIVE using the M4 screws supplied.
2. Secure the second pivot base to the location you have selected for mounting the IsatDock2 DRIVE.
3. Use the interconnecting arm of the RAM® mount to secure the IsatDock2 DRIVE to the pivot base and tighten into the desired position firmly using the wing nut on the arm.

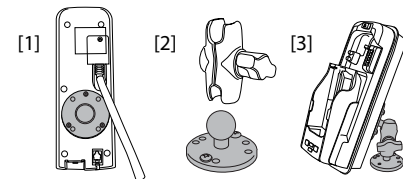

2) Beam Antenna Connection

The antenna connections exit from the rear of the IsatDock2 DRIVE cradle, via the antenna loom. There are two RF connections required, the Satellite Connector (TNC-Female) and GPS Connector (SMA-Female).

1. Refer to the antennas installation guide for antenna mounting and location requirements.
2. Connect the antenna cable labelled "Inmarsat" to the IsatDock2's TNC connector
3. Connect the antenna cable labelled "GPS" to the IsatDock2's SMA connector
4. Connect the antenna cable labelled "Inmarsat" to the antenna connector labelled "SAT" via the SMA connector.
5. Connect the antenna cable labelled "GPS" to the antenna connector labelled "GPS" via the SMA connector

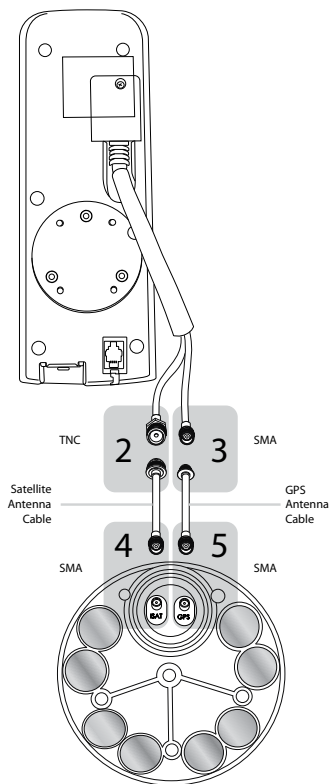

WARNING

DO NOT pull with force on the cables from the rear of the IsatDock2 DRIVE. Please install strain relief clamping for the antenna cables where required. Correct installation of the antenna system is a vital part of the IsatDock2 DRIVE system, to ensure reliable functionality, and drop-free calls.

WARNING

Changes or modifications not expressly approved by Beam Communications could void the product warranty.

WARNING

To satisfy FCC RF exposure requirements for mobile transmitting devices, a separation distance of 55 cm or more should be maintained between the antenna of this device and persons during device operation. To ensure compliance, operations at closer than this distance is not recommended.

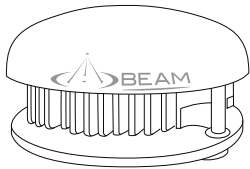

Transport Antenna
(Active)



ISD715
Magnetic Mounting



ISD720
Bolt Mounting



NOTE

Refer to the section "Antenna Installation" for more information on antenna placement and installation. Only Beam approved antenna cables should be used with all docking stations and antennas.

3) Connecting Speaker and Microphone

The IsatDock2 DRIVE cradle comes with an external speaker and microphone for hands-free operation.

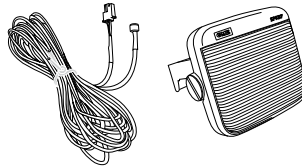

1. Mount the speaker in the appropriate location and ensure the lead is sufficient to reach the cradle.



NOTE

The speaker outputs are a Class D amplifier, which must not be connected to chassis/ground.

2. Mount the microphone about 30cm away from where you normally speak and ensure the lead is sufficient to reach the cradle. By default, the audio is always on the hands-free speaker and microphone unless a privacy handset audio device is enabled.

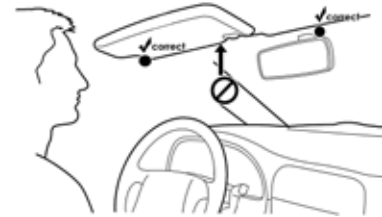

4) Connect Privacy Handset (Optional Extra)

The IsatDock2 DRIVE provides a RJ9 audio socket on the bottom of the docking unit, for connection to the Beam privacy handset. This provides a local handset function, conveniently mounted next to the IsatDock2 DRIVE cradle.

1. The Privacy Handset Kit (purchased/ordered separately) contains a bracket, spacer plate, screws, washers and nuts.

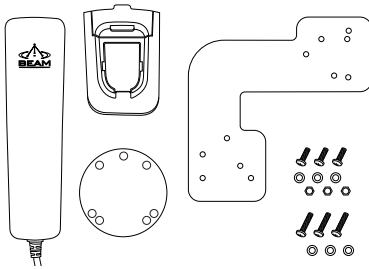

2. Mount the handset cup to the bracket which can be installed to the left or right side of the dock. Use the washers and nuts behind the bracket to secure the cup.

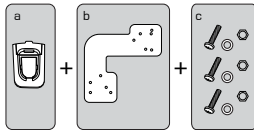

- [a]** Handset cup **[b]** Mounting bracket
[c] 3 x M4x14 screws, washers and nuts

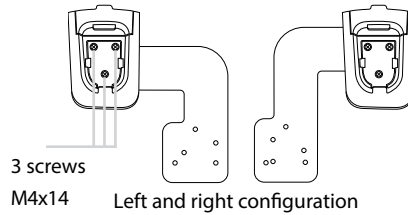

3. Mount the spacer plate and the mounting bracket to the rear of the IsatDock2 DRIVE, by using the longer screws provided with the kit. The original RAM® Base is also reinstalled on top of the plate and spacer. Install in the following order:

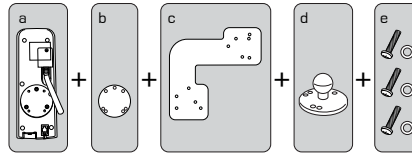

- [a]** Rear of IsatDock2 DRIVE **[b]** Spacer plate
[c] Mounting bracket **[d]** RAM® base
[e] 3 x M4x18 screws and washers

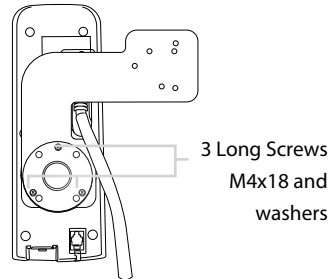

4. Plug the Privacy Handset RJ9 connector into the bottom of the docking unit.

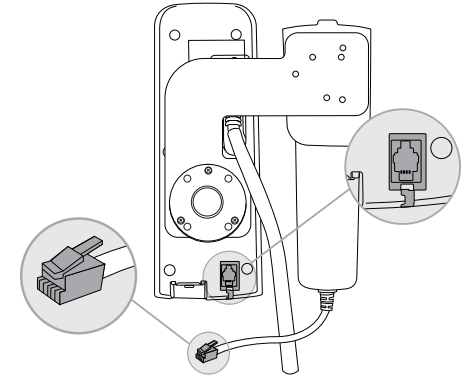

Privacy Handset mode is enabled when the handset is removed from the cup. Please ensure to re-dock the Privacy Handset when not in use.

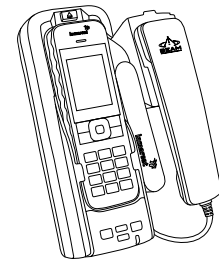

5) Connecting DC Power Cable

The Dock can be powered from the supplied 10-32V DC power cable/lead.

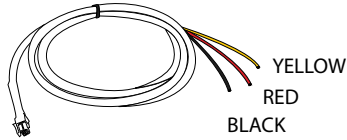

The DC power cable has three wires, RED, BLACK and YELLOW. The RED and BLACK wires are used for the power connection while the YELLOW wire can be connected to a vehicle's accessories, ignition or other similar circuits to control the ON/OFF status of the IsatDock2 DRIVE in synchronization with a vehicles operation. By default, the IsatDock2 DRIVE will stay on for 20 minutes after this input is switched off. If a call is in progress while this occurs, the IsatDock2 DRIVE will stay on for 20 minutes after the call is terminated. Please follow the steps to connect the DC power cable to the vehicle

battery power and the IsatDock2 DRIVE.

1. Route the wire end of the DC power cable to the connection point. DO NOT apply power until the following steps are completed.
2. Connect the BLACK wire to the negative terminal of the battery (10A fuse recommended) or the vehicle chassis (if negatively grounded chassis).
3. Connect the RED wire to the positive terminal of the battery. It is recommended to add the 5A fuse supplied, between them.
4. Connect the YELLOW wire to the vehicle accessory power. If the accessory power is unavailable, this may be connected to a vehicle ignition voltage. It is recommended to add a 1A fuse between them. The accessory wire enables the IsatDock2 DRIVE to turn on and off as the vehicle key is enabled or disabled. If this function is not required, the YELLOW wire MUST be connected to the RED wire.

5. Connect the 4-way Microfit connector on the DC power cable to the 4-way power connector on the rear cable loom of the IsatDock2 DRIVE.

Wiring for a Marine Application

When installed in a marine application using the DC power cable, the YELLOW wire can be wired to a suitable panel switch which will allow the IsatDock2 DRIVE to be turned off when not in use.

Optional ISD951 AC Plug Pack Installation

For installation with the optional ISD951 110-240 AC plug pack connect the 4-way Microfit connector from the plug pack to the 4-way power connector on the rear cable loom of the IsatDock2 DRIVE. In this configuration the ignition/accessory status is always ON.

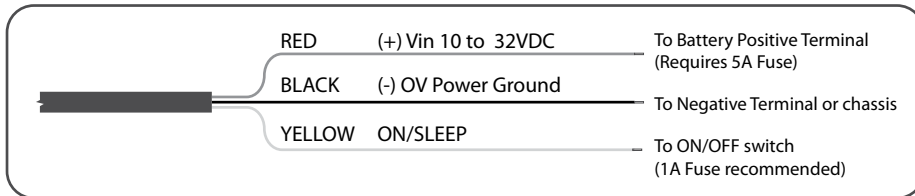
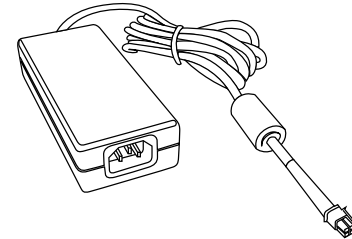

6) Connecting Horn and Mute Wires

Horn Alert Output (If required)

The IsatDock2 DRIVE provides a BLUE wire output on the rear cable loom for controlling an external ringer such as a vehicle horn. The horn output is an open collector output capable of sinking up to 120mA current. It CANNOT be connected to the vehicle horn directly and an automotive grade relay must be used to control the horn as shown below.

By default, it only works when the key ignition is OFF and the IsatDock2 DRIVE is still ON (by default, the IsatDock2 DRIVE will stay on for 20 minutes after the key ignition is turned OFF). This is to avoid the horn buzzing on an incoming call while the vehicle is being driven.

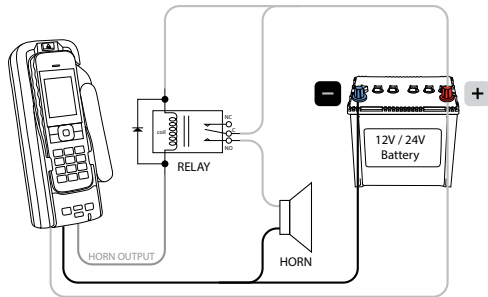

Radio Mute Feature

The entertainment mute output connects to the mute input on your car radio, if the radio includes a mute function. The entertainment mute feature automatically mutes the radio system when you place or receive a call. This feature needs to be supported by a car radio that supports in functionality.



NOTE

This output signal from the "Mute" connector sinks a maximum of 100mA (0.1A) to ground

7) Connecting the Beam Alert Loop (optional)

IsatDock2 DRIVE provides an additional cable pair from the rear cable loom, known as the Beam Alert Loop. This provides a Normally CLOSED wire loop, which can be used to connect to any passive type of button, relay, or reed switch in which the action breaks the loop (OPEN) to activate the Programmable Assistance state.

Connect the BROWN and GREEN wires either directly to the button, or it can be extended for longer runs (up to 45 meters). This loop can support multiple buttons / switches – wired in

SERIES, whereby any one of these buttons will OPEN (activate) the loop when pressed.

To properly activate the Assistance Alert, the loop needs to be OPEN for at least 2 seconds – (ie. holding down the button for 2 seconds activates the Assistance mode).



NOTE

If the Beam Alert Loop is going to be used with an external button, remember to enable this external loop in the Falcon settings. Once enabled, the loop will be armed and activated with an open-loop condition, triggering on Assistance Alert on the IsatPhone 2.

To avoid false triggering, be sure to have the normally closed button wired into the Beam Alert Loop, before applying power.

IsatDock2 DRIVE Usage

Operation of the IsatPhone 2

Prepare the Inmarsat IsatPhone 2

Ensure that the IsatPhone 2 Handset has the latest compatible firmware installed. For more information visit:

www.beamcommunications.com/support/isd2drive

Starting Up

1. Retract the antenna on the IsatPhone 2 handset.
2. Place the IsatPhone 2 as per instructions “Docking & Undocking” on page 14.
3. Turn vehicle ignition on. The IsatPhone 2 will automatically power and the handset will then start to initialise followed by a 3 tone rising beep when a successful connection has been made between the docking station and the IsatPhone 2.
4. Wait for the IsatPhone 2 handset to register on the Inmarsat network. The STATUS LED on the docking station will turn green when a successful registration has taken place.
5. You are now ready to make and receive calls.



NOTE:

- 1) *If the IsatPhone 2 is removed from the dock during a call, the call will drop out during this transition.*
- 2) *One common cause for connection failure is a flat IsatPhone 2 battery which prevents the IsatPhone from turning ON. In these instances the docking station will attempt to charge the IsatPhone 2 handset while it is switched OFF, until enough charge is present for the IsatPhone 2 to turn ON. This charging period can take up to 20 minutes depending on how flat the battery.*

Charging the IsatPhone 2 handset

The IsatDock2 DRIVE provides charging power to the IsatPhone 2 handset via its USB connector.

The IsatPhone 2 battery is a lithium-ion cell which has a safety temperature range whilst charging. This range is from 0-45°C (32-113 °F). Due to the increased heating effects on the IsatPhone 2 handset whilst it is docked and being charged, it is ideal for the ambient temperature to be at least 18 degrees below the 45°C upper limit for the handset to charge the battery whilst docked. If the battery temperature exceeds this

limit, then the IsatPhone 2 may cease charging until the temperature is reduced.

Placing Voice Calls

Bluetooth® calls via IsatPhone 2

The IsatDock2 DRIVE allows for Bluetooth audio calls to be placed via the IsatPhone 2 handset while docked. Consult the IsatPhone 2 manual for further information on pairing and Bluetooth discovery setup.

Hands-Free Phone Call – Mobile Originating

1. Dial the number (using the full country codes) on the IsatPhone 2 handset keypad whilst docked. Press the GREEN key to start the connection.
2. A message will display on the IsatPhone 2 handset to indicate the call is progressing.

Options:

- A. During the call, you may transfer the call to the optional privacy handset by taking the privacy handset out of its cup. This automatically directs the call audio to the privacy handset.
- B. To return the call back to hands-free mode, place the privacy handset back in its cup.

Hands-Free Phone Call – Mobile Terminating

Make a call from your landline phone or mobile phone to the IsatPhone 2 handset. You need to know the phone number of the SIM card used in the IsatPhone 2 handset.

1. The IsatDock2 DRIVE external speaker will ring according to the ringer setting of the IsatPhone 2.
2. Answer the call by pressing the GREEN key on the IsatPhone 2 handset.

Once the call is in progress, options A and B from “Hands-free Phone Call – Mobile Originating” section are also applicable.

Privacy Handset Use (Optional Accessory)

Privacy handset Phone Call - Mobile Originating

1. Remove the privacy handset from its cup
2. Dial using the full Inmarsat dialing sequence eg. 00 country code and telephone number on the IsatPhone 2 keypad whilst docked. Press the GREEN button to start the connection.
3. A message is displayed on the IsatPhone 2 to indicate a call is in progress.
4. Once the call is connected, the STATUS LED will flash to indicate a call is in progress.

5. Press the RED key on the IsatPhone 2 handset to terminate the call.

Privacy Handset Phone Call - Mobile Terminating

1. Answer the incoming call by un-cupping the privacy handset from its cup.
2. Press the RED key on the IsatPhone 2 handset or return the privacy handset to its cup to terminate the call.

Mute Mode

Mute functionality

The mute function of the IsatDock2 DRIVE allows the user to mute the uplink microphone audio on the privacy handset and/or external hands-free microphone.

1. During a call, Press the Mute button on the face of the IsatDock2 DRIVE, a RED LED will illuminate the Mute button to confirm that the IsatDock2 DRIVE is muted.
2. To exit the mute mode, press the mute button once.

USB Driver Installation

The IsatDock2 DRIVE USB data port requires an interface driver to be installed on the user’s computer prior to undertaking data communication.

Personal Alert, Assistance Alert and Tracking Configuration (optional)

Personal Alert & Assistance Alert Operations

Please refer to the Inmarsat IsatPhone 2 User Manual to configure the Personal Alert and Assistance button operation and destinations.

Initiate an Instant notification

When the Personal Alert button of the IsatDock2 DRIVE is pressed, the IsatPhone 2 handset will trigger and send a GPS position and short message via SMS or email according to your handset's settings.

Refer to IsatPhone 2 User Manual for further information.

Assistance Alert

IsatDock2 can be configured to trigger the Assistance Alert function of the IsatPhone 2 handset via the Beam Alert Loop. The Alert can also be activated by pressing the Assistance button on the top of the handset when docked. Assistance Alert must be configured to Handsfree Call > OFF in the IsatPhone 2 Settings, to ensure correct handsfree operation when docked.



IMPORTANT

If the Beam Alert Loop is going to be used with an external button, remember to enable this external loop in the Falcon settings. Once enabled, the loop will be armed and activated with an open-loop condition, triggering an alert on the IsatPhone 2.





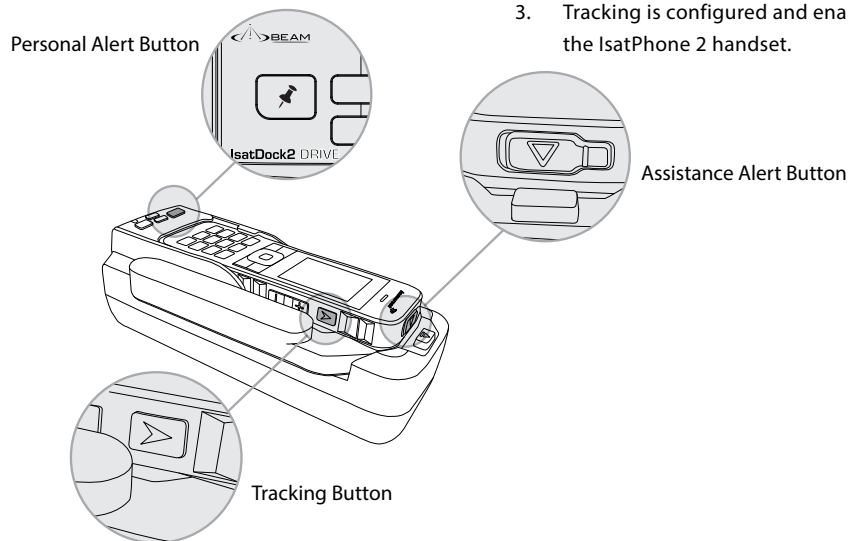

IsatPhone 2 Tracking Functionality

The Tracking Button turns the periodic tracking functionality of the Isatphone 2 ON and OFF. In order to send a tracking message, the following conditions must be fulfilled for a docked handset.

1. The GPS receiver of the IsatPhone 2 has acquired enough satellite signals and navigational data to calculate a positional solution (fix).
2. The IsatPhone 2 is registered with the GSPS network.
3. Tracking is configured and enabled on the IsatPhone 2 handset.



IsatDock2 DRIVE Front Panel

Location	Button Mode	Action	LED/Sound
	Single Press (1 second)	Send a Personal Alert message to the IsatPhone 2's pre-configured destination*	A beep will sound to indicate that a Personal Alert button was pressed.#
	Mute Press ON/OFF	In a Call: Mute the microphone (uplink) on the privacy handset if connected to cradle.	LED turns RED - Muted LED turns OFF - Not muted
 OR 	UP/DOWN	In a Call: Increase/decrease volume on the internal hardware or privacy handset (optional accessory) if connected to cradle. Out of Call: Increase/decrease volume of incoming ring tone on the internal hardware speaker.	Audio will sound louder/quieter in privacy handset with each press. A beep will sound indicating the increased/decreased ring tone volume
 + 	Brightness dual button simultaneous press (1 second)	Out of Call: Enter LED brightness change mode. Press UP and DOWN arrows to vary intensity. Mode will automatically exit after 5 seconds after the last button press.	All LED's will change to WHITE and a double beep will sound when entering brightness change mode. A short single beep will sound when exiting change mode.

* This action is optional, only when the Personal Alert Mode for your IsatPhone 2 is configured.

A beep will only sound if audible alerts are enabled in the Falcon

IsatDock2 DRIVE Buttons/LED lights

MUTE BUTTON	GREEN	RED	YELLOW	WHITE/OFF
ILLUMINATED	N/A	Outgoing audio is muted	N/A	Outgoing audio is not muted
STATUS LED	GREEN	RED	YELLOW	WHITE/OFF
ILLUMINATED	Handset registered and able to make a call	Handset not registered/ no signal and cannot make or receive calls	N/A	N/A
FLASHING	Call in Progress	N/A	N/A	N/A
ALTERNATING	N/A	Error detected in communicating with IsatPhone 2 handset. Flashing RED/BLUE	N/A	N/A

1. Personal Alert Button
2. Mute
3. Up & Down
4. STATUS LED

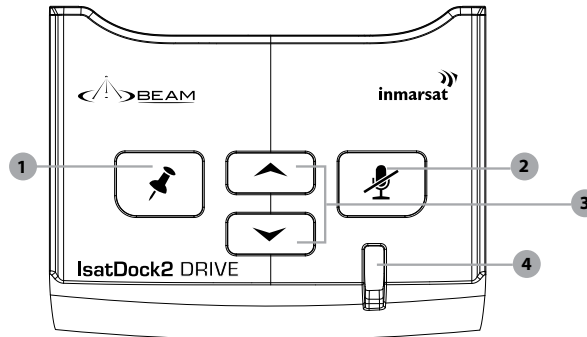

Assuring Quality of Service

There are conditions that can compromise the quality of the service you may receive. These include:

- Obstructions
- Cabling
- RF Interference

Obstructions

Nearby tall buildings or similar structures, heavily leafed trees and mountains can all degrade performance as they block the signal between the antenna and the satellites.

Inmarsat performance is immune from natural environments such as clouds, fog, rain, snow, wind and smoke.

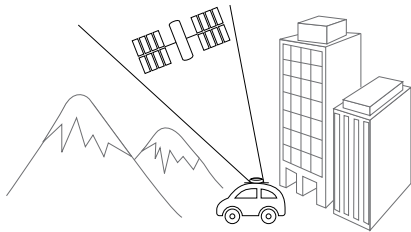

Cabling

Using an externally mounted antenna provides an ideal solution for many applications. It is very important that both the antenna cabling and antenna are Beam approved products. Always ensure all RF connectors are screwed together firmly and ensure there are no sharp bends in the cabling between the docking station and the antenna.

RF Interference

All wireless devices, including satellite telephones, are susceptible to RF (radio frequency) interference from other electronic devices. This problem is more evident when numerous antennas and broadcasting devices are located within close proximity to each other.

Symptoms of RF Interference

Symptoms of RF interference often resemble those that arise when an antenna is being operated with an obstructed view of the sky. Some of these symptoms include; erratic or no signal strength indication dropped calls or warbled or otherwise distorted voice. These symptoms may be intermittent or persistent, depending largely on the interference source, its distance, strength and frequency relative to the antenna.

Mitigation of RF Interference

Service degradation due to RF interference can be significantly improved by:

- Increasing the distance and moving the antenna off axis from the source of the interference, and
- Using an external band pass filter and an external antenna.



WARNING

Failure to use Beam approved antenna cables will result in degraded performance and may damage the Docking Station. This will void the product warranty.

Specification Summary

Electrical & Environmental Specifications - IsatDock2 DRIVE

Average Power Consumption Current @ 12V	Average	Watts
Power w/o IsatPhone 2	130mA	1.6W
Standby + Charging	360mA	4.3W
Transmit + Charging	875mA	10.5W
Sleep Mode	5mA	60mW
Peak Current	3.5A	42W
Physical Specifications	Metric	Imperial
Dimensions	229 x 99 x 76 (mm)	9.0 x 3.9 x 3.0 (inches)
Weight - dock	670g	1.47lbs
Total Kit Weight	1.67kg	3.68lbs
Environmental Specifications		
Operating Range	-30°C to +70°C	-22°F to +158°F
Storage	-35°C to +85°C	-31°F to +185°F
Battery Charging Temp*	0°C to +45°C	+32°F to +113°F
Humidity	<= 75% RH	
I/O Alert		
1 x Beam Alert Loop	Bare wire - "Normally closed" loop IN to OUT	
Personal Alert	In-built - single key press	
Connectors / Interfaces		
Beam Antenna	TNC-Female	

GPS Antenna	SMA-Female
10-32V DC	4-way microFit (AC/DC adapter, or DC lead)
Privacy Handset Port	RJ9 connector
Speaker	2-way microFit / Class D, >3W 8ohm
Microphone	2-way microFit / 2.5V DC bias electret
Certifications	
Inmarsat Type Approval, FCC, CE Compliance, Electrical Safety, RoHS, Industry Canada, C-Tick, EMC Compliance	
Accessories	
ISD715 - Transport Magnetic Antenna (Active)	
ISD720 - Transport Bolt Antenna (Active)	
ISD932 - 6m SMA/TNC cable kit (Active)	
ISD933 - 13m SMA/TNC cable kit (Active)	
ISD934 - 18m SMA/TNC cable kit (Active)	
ISD935 - 30m cable kit (Active)	
ISD938 - 40m cable kit (Active)	
ISD942 - 50m cable kit (Active)	
ISD943 - 60m cable kit (Active)	
ISD944 - 70m cable kit (Active)	
ISD945 - 80m cable kit (Active)	
ISD946 - 90m cable kit (Active)	
ISD947 - 100m cable kit (Active)	
ISD951 - 110-240v AC plug pack	

ISD955 - Privacy Handset
ISD960 - IsatDock2 Adapter
RST410 - "Man Down Pendant" kit
RST060 - Beam GoalZERO UPS Battery Pack
Kit Contents
IsatDock2 DRIVE
2x IsatDock2 Adapters
10-32V DC power cable / fuse kit
Speaker
Microphone
Universal mounting bracket (RAM®)
User manual
Quick start guide



NOTE:

Specifications are subject to change without notice.

* It is ideal for the ambient temperature to be approximately 18 degrees below the 45°C upper limit for the handset to charge the battery whilst docked.

(1) Physical Dimensions - ISD2 DRIVE Dock

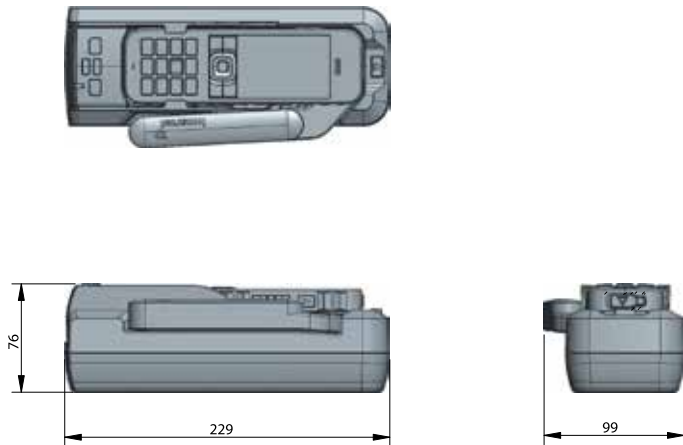

(2) Physical Dimensions - with optional Privacy Handset

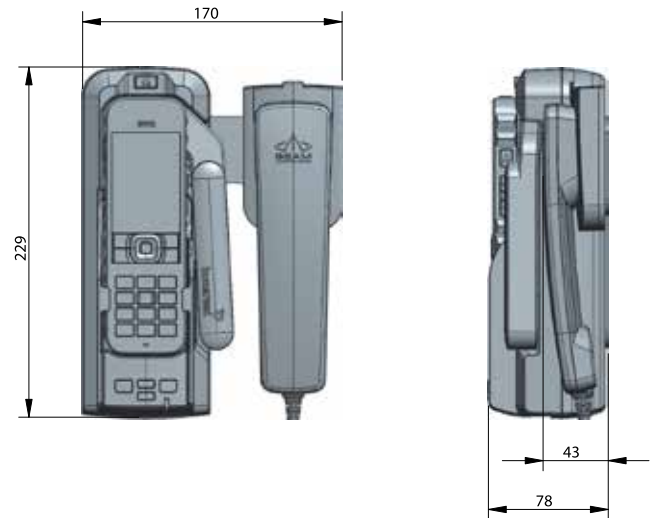

NOTE:

When mounting the privacy handset to the left of the dock, the width measurement becomes 185mm

Trouble Shooting

This chapter provides information to help you troubleshoot problems you may encounter while running the IsatDock2 DRIVE.

Q1	How do I know if my IsatPhone 2 is registered on the Inmarsat network?
A	The STATUS LED of the docking station will change to GREEN when the handset is registered and able to make calls on the network. The IsatPhone 2 will also indicate "Inmarsat" in the top left corner of the screen display.
Q2	The handset and docking station turn's OFF every 20minutes?
A	Ensure the Ignition/Accessories wire is connected to power. If this is not connected, or connected to ground the docking station will go into sleep mode after 20 minutes by default.
Q3	No power on IsatDock2.
A	Check power is connected to the interface unit. If applicable, check the vehicle ignition is in ACC or IGN or ON position. Ensure the Connector cable to the IsatDock2 is firmly fitted. Check all the connection cables to and from the IsatDock2.

Q4	The signal bars are low or fluctuating and call quality is poor.
A	Ensure all antenna connectors are tight. The antenna is operating in a location that it can see the satellite and there are no obstructions. Beam certified antenna cabling is being used and there are no sharp bends or cuts in the cable. If using a fixed passive antenna, ensure it is orientated correctly and pointing at the satellite.
Q5	I am looking for the latest manuals and support information on the docking station ?
A	Visit: http://www.beamcommunications.com/support
Q6	Dropped calls
A	Due to a satellite network when you are in motion the satellite signal may become obstructed (such as buildings, bridges, tunnels, larger vehicles). Check the antenna connection. Ensure the antenna cable has not been damaged. Ensure that only approved antenna cable has been used. Refer to Antenna Install Guide on Beam website support.

Q7	Party B cannot hear your voice.
A	Privacy Handset must be docked in its cup when not in use. Check that MUTE is not ON (indicated by turning RED) Check the signal strength on the handset. Ensure the Headset connector at the base of the IsatPhone 2 is not obstructed and there is no dust or foreign objects in the connector socket.
Q8	The docking station appears to be turning ON/OFF and the handset is not registering.
A	Ensure the power supply can provide at least 3.5A at 12volts. If power is being supplied from a battery, ensure the connections are tight and the contacts are clean.

Beam Warranty Conditions

Beam Communications gives this express warranty (along with extended warranty endorsements, where applicable) in lieu of all other warranties, express or implied, including (without limitation), warranties of merchantability and fitness for a particular purpose. This constitutes our sole warranty and obligation with regard to our products as well as the Customer's sole remedy.

Beam Communications expressly disclaims all liability and responsibility for any special, indirect or consequential damages or any further loss of any kind whatsoever resulting from the use of our product(s).

The Customer's sole and exclusive remedy and the limit of BEAM liability for any loss whatsoever, shall not exceed the purchase price paid by the Customer for the product to which a claim is made.

All products manufactured by Beam Communications are warranted to be free from defects in material and workmanship in accordance with and subject to the following terms and conditions:

1. This warranty is limited to the original Customer only. It cannot be transferred or assigned to third parties unless the intent to transfer to a third party is expressly indicated in a purchase order and/or warranty-processing arrangements have been agreed upon in writing by Beam.
2. Beam Communications does not warrant any installation, maintenance or service of the Products not performed by Beam, nor does it warrant the use of Products with unapproved ancillary products.
3. Beam Communications will correct any defects in material or workmanship of products manufactured by Beam which appear within (12) months and (24) months replacement warranty for Docking Station units ONLY, from the date of shipment by Beam Communications to the Customer.
Beam Communications will repair or replace, at our option, any defective product, provided that our analysis and/or inspection discloses that such defects developed under normal and proper use.
4. This warranty does not extend to goods subjected to liquid or particulate ingress, extreme humidity, misuse, neglect, accident or improper installation, or to maintenance or repair of products that have been altered or repaired by anyone except Beam Communications unless otherwise stated in writing.
5. The warranty is a return-to-base warranty and freight is paid by the sender.
6. A charge of USD \$195 including return freight will be made for testing returned product which is not defective or is found to be defective as the result of improper use, maintenance or neglect.
7. Beam Communications will not accept responsibility for any invoiced goods or services that are not covered by a Beam Communications written purchase order. Under no circumstances does Beam Communications agree to pay for labour or other related expenses associated with the troubleshooting and/or repair of our product without prior specific written authorization.
8. Information in our descriptive literature is based on product specifications that are current at the time of publication. Product specifications, designs and descriptive literature are subject to change as improvements are introduced. Although we announce changes as they occur, we cannot guarantee notification to every Customer. Beam Communications warrants delivered product to conform to the most current specifications, designs and descriptive literature.
9. This warranty policy may be expanded or limited, for particular categories of products or Customers, by information sheets published as deemed appropriate by Beam Communications. The warranty for third party Products is that of the third party and not Beam warranty.

BEAM Communications

GLOBAL HEAD OFFICE

Tel: +61 3 8588 4500 Fax: +61 3 9560 9055

AMERICAS

Tel: +1 800 250 5819 (USA toll free) Fax: +1 888 972 8037

EUROPE

Tel: +44 208 144 1405 Fax: +44 208 289 3542

Info: info@beamcommunications.com

Support: support@beamcommunications.com



www.beamcommunications.com