

Transport Magnetic Antenna Kit Contents

1. Transport Antenna
2. Magnetic Mounting Plate
3. 2 x SMA-SMA Right Angled Adaptors
4. SMA RF Connector Spanner
5. 3 x Small Screws
6. 3 x Large Screws
7. 6 x Small Split Washers
8. 6 x Small Flat Washers

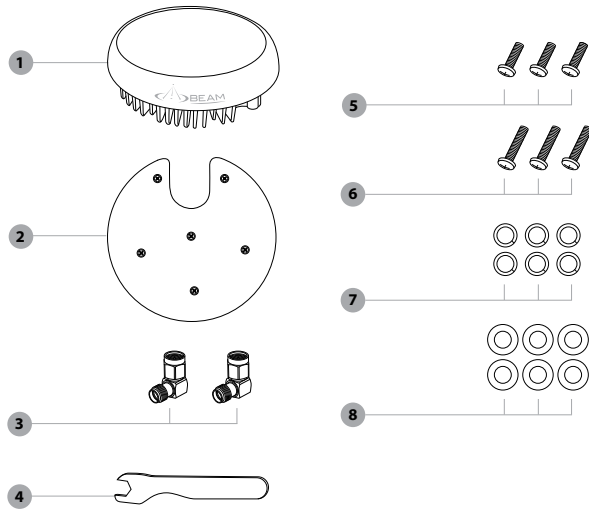

ANTENNA SPECIFICATIONS

AMPLIFIER + INTEGRAL ANTENNA		CHANNEL SPACING	N/A
EQUIPMENT TYPE	Mobile or Fixed Base Station	OCCUPIED BANDWIDTH (99%)	83.1 KHz
INTEGRATED OPERATING ENVIRONMENT	[x] Commercial [x] Light Industry & Heavy Industry	MODULATION	TX Modulation: GMSK RX Modulation: OQPSK
POWER SUPPLY REQUIREMENT	DC 12-32 Volts maximum	EMISSION DESIGNATION*	G7W
RF INPUT POWER RATING (US & CANADA)	30.0 dBm or 1.0 Watt peak (conducted)	ANTENNA CONNECTOR TYPE	Integral
RF OUTPUT POWER RATING (US & CANADA)	37.5 dBm or 5.6 Watts peak (conducted)	ANTENNA DESCRIPTION	Manufacturer: Aeroantenna Technology, Inc. Type Drive Model: AT1595-83 Frequency Range: GPS 1565.19- 1585.65 MHz, Inmarsat Receive: 1518-1559 MHz, Inmarsat Transmit: 1626.5-1660.5 MHz GPS Amplifier Gain: 26 dB INMARSAT RECEIVE Amplifier: 26 dB INMARSAT TRANSMIT Amplifier: 11 dB Antenna Element Gain: 6dBi max.
DUTY CYCLE	N/A	AMBIENT TEMPERATURE RATING	-40°C to +80°C
TX OPERATING FREQUENCY RANGE	1626.5 - 1660.5 MHz	STORAGE OPERATIONAL:	-25°C to +55°C
RX OPERATING FREQUENCY RANGE	1565.19- 1585.65 MHz (GPS) 1518-1559 MHz (Inmarsat 1518-1559 MHz)		
RF OUTPUT IMPEDANCE	50 Ohms		



WARNING

All antenna cables used must be compliant with approved dB signal loss. Failure to use Beam approved antenna cables may result in non-compliance, degraded performance and may damage the IsatPhone Pro.

This device complies with Part 15 of the FCC Rules. Operation is subject to the following two conditions: (1) this device may not cause harmful interference and (2) this device must accept any interference received, including interference that may cause undesired operation.

To Satisfy FCC RF exposure requirements for mobile transmitting devices, a separation distance of 55cm or more should be maintained between the antenna of this device and persons during device operation. To ensure compliance, operations at closer than this distance is not recommended.

The antenna used for this transmitter must not be co-located in conjunction with any other antenna or transmitter.

PART #: USRMAN006303M

BEAM Communications
5/8 Anzed Court, Mulgrave
Victoria, 3170, AUSTRALIA

Web: www.beamcommunications.com
Info: info@beamcommunications.com
Support: support@beamcommunications.com
Tel: +61 3 8588 4500
Fax: +61 3 9560 9055



ISD715
Transport Magnetic Antenna
(Active)

Installation Guide



Suitable for IsatDocks

Transport Magnetic Antenna Installation Guide

Step One:

Attach the "SMA-SMA right angled adaptors" to both the ISAT and GPS connectors on the underside of the antenna.

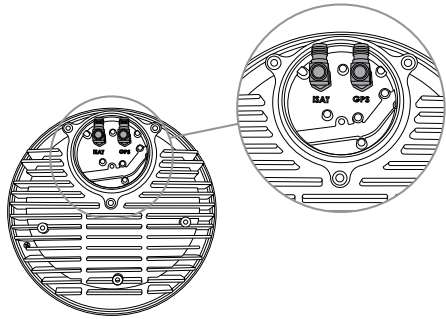

Step Two:

1. Connect the antenna cable labelled "Inmarsat" to the IsatDock's TNC connector
2. Connect the antenna cable labelled "GPS" to the IsatDock's SMA connector
3. Connect the antenna cable labelled "Inmarsat" to the antenna connector labelled "ISAT" via the SMA connector.
4. Connect the antenna cable labelled "GPS" to the antenna connector labelled "GPS" via the SMA connector

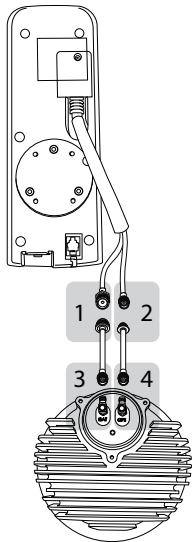

Step Three:

Place the Magnetic Mount plate on the back of the transport antenna making sure to align the screw holes.

Connects to IsatDock

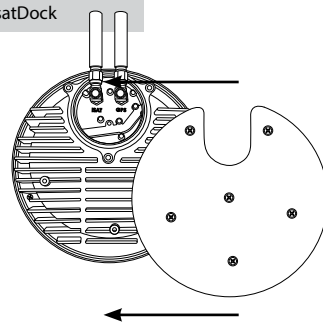

Step Four:

Use the 3 small mounting screws (with a split washer and a flat washer on each) on the lower 3 holes and the 3 large mounting screws (with a split washer and a flat washer on each) on the upper 3 holes as shown below.

Connects to IsatDock

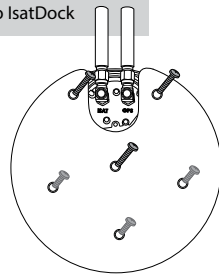

Step Five:

Once completed place the antenna where required.

Connects to IsatDock

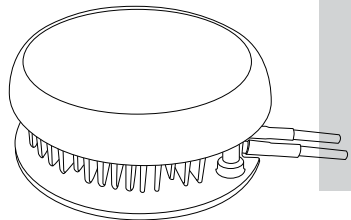

Antenna Coverage

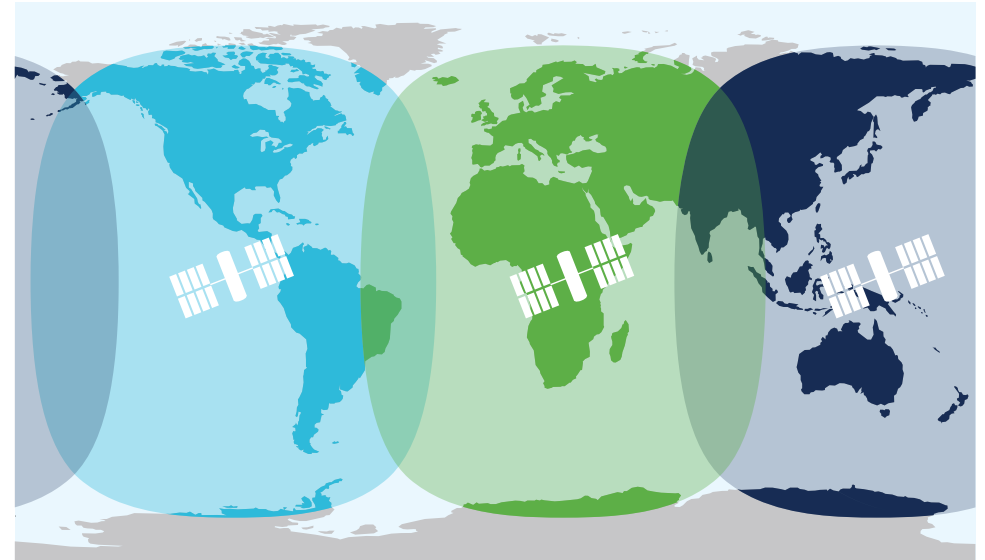

I-4 Americas

I-4 EMEA

I-4 Asia-Pacific

Sourced from Inmarsat

Installation Guidelines

To ensure maximum performance of the antenna system and to maximise availability and reliability of service the antenna must;

- have a clear line of site to the sky
- be clear and free of obstructions
- be clear of metal objects
- be located away from other transmitting devices
- be securely affixed in location
- not be located indoors
- be installed in conjunction with a certified cable

- Mount all antennas vertically and clear of nearby metal obstructions.
- Minimize horizontal obstructions as much as possible because they can create areas of poor system coverage.

Installation Options

The antenna system is suitable for marine, vehicle and fixed applications and is designed to meet Inmarsat System performance requirements when installed according to the instructions in this guide.

The following figure shows typical Installations:

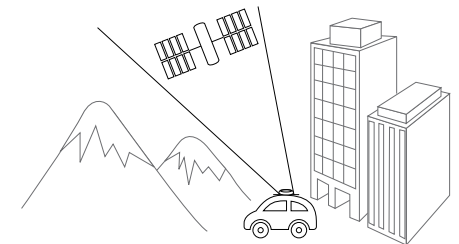

The antenna must be installed without obstruction of other instruments or structures. The antenna must not be positioned within range of radar equipment or other RF interference.

Installing Antenna Cables

When installing antenna cables, follow these guidelines:

- Route and restrain cables to prevent them from vibrating or moving under normal conditions, which could result in damage to the antenna or the coaxial cable connections.
- Where ever the cables contact structures, protect the cables from chafing or abrasion. If a cable needs to be bent, avoid kinking it, and ensure that each bend radius follows the cable supplier limits.
- Use coaxial sealant, shrink-wrap tubing, electrical tape, or another suitable product to seal all cable connections appropriately to prevent moisture and corrosion damage from weather exposure.



NOTE:

For Satellite & GPS connection instructions please consult your Beam Inmarsat Product manual.



WARNING

To satisfy FCC RF exposure requirements for mobile transmitting devices, a separation distance of **55 cm** or more should be maintained between the antenna of this device and persons during device operation. To ensure compliance, operations at closer than this distance is not recommended.